

**XFM-SE146**  
DUAL CARBIDE - REPLACES PART# MINI-DUO-228

CUTTER TYPE	STEEL TYPE	STEEL HARDNESS	SINGLE BOLT REQUIRED	WEIGHT
Wood	42CrMo	HRC40-42	(1) M16x1.5x90 HEX	3.66 lbs

aftermarket replacement for:  
**SEPPI**  
fit models - BMS-F, H-SMWA-K, MINI BMS, BMS-L, BMS, SUPER BMS, MINFORST, MIDIFORST, MIDIFOREST dt, MIDIFORST Fresa, STARFORST, SUPERFORST, MAXIFORST

A	B	C
LENGTH	WIDTH	WIDTH
4"	1-7/8"	3-1/16"

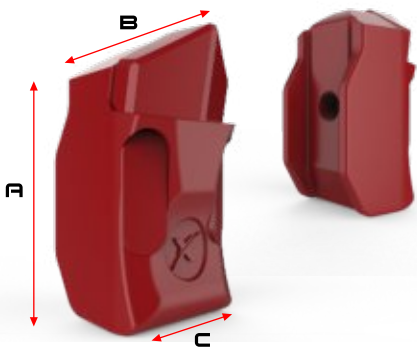

**XFM-SE147**  
SINGLE ROCK CARBIDE - REPLACES PART# MINI-DUO-228

CUTTER TYPE	STEEL TYPE	STEEL HARDNESS	SINGLE BOLT REQUIRED	WEIGHT
Rock/Wood	42CrMo	HRC40-42	(1) M16x1.5x90 HEX	3.60 lbs

aftermarket replacement for:  
**SEPPI**  
fit models - BMS-F, H-SMWA-K, MINI BMS, BMS-L, BMS, SUPER BMS, MINFORST, MIDIFORST, MIDIFOREST dt, MIDIFORST Fresa, STARFORST, SUPERFORST, MAXIFORST

A	B	C
LENGTH	WIDTH	WIDTH
4"	1-7/8"	3-1/16"

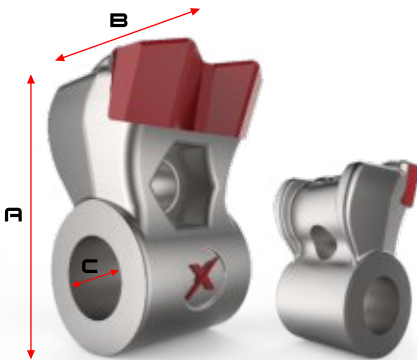

**XFM-SE180**  
DUAL ROCK CARBIDE - REPLACES PART# MIDIFORST-193

CUTTER TYPE	STEEL TYPE	STEEL HARDNESS	SINGLE BOLT REQUIRED	WEIGHT
Rock Crushing	42CrMo	HRC40-42	(1) M20x1.5 HEX	4.30 lbs

aftermarket replacement for:  
**SEPPI**  
fit models - MINIFORST, MIDIFORST dt, MIDIPIERRE dt

A	B	C
LENGTH	WIDTH	DIA
4"	2-3/4"	1-1/4"

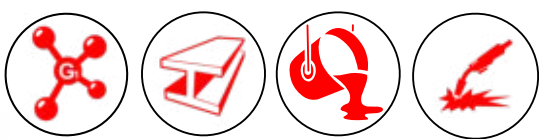
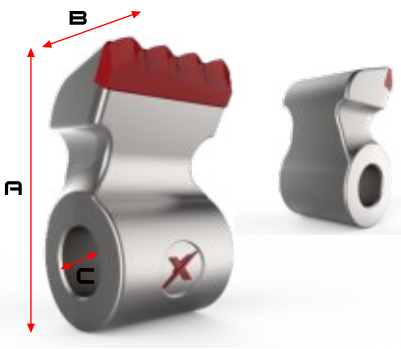

**XFM-SE181**  
FOUR CARBIDE - REPLACES PART# SUPERFORST-193

CUTTER TYPE	STEEL TYPE	STEEL HARDNESS	SHAFT REQUIRED	WEIGHT
Wood / Rock	42CrMo	HRC40-42	1-3/8" Dia	8.80 lbs

aftermarket replacement for:  
**SEPPI**  
fit models - SUPERFORST 200, 225, 250

A	B	C
LENGTH	WIDTH	DIA
3-1/2"	5-1/2"	1-3/8"

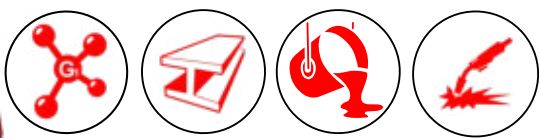
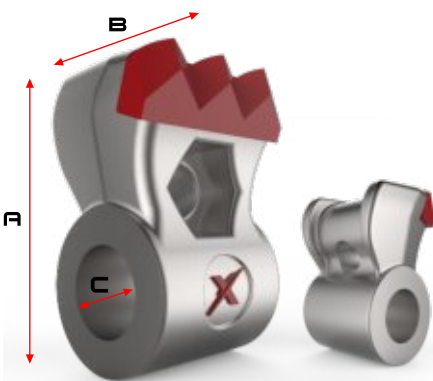

**XFM-SE182**  
THREE CARBIDE - REPLACES PART# MIDIFORST-193

CUTTER TYPE	STEEL TYPE	STEEL HARDNESS	SINGLE BOLT REQUIRED	WEIGHT
Wood / Rock	42CrMo	HRC40-42	(1) M20x1.5 HEX	3.80 lbs

aftermarket replacement for:  
**SEPPI**  
fit models - MINIFORST, MIDIFORST dt, MIDIPIERRE dt

A	B	C
LENGTH	WIDTH	DIA
4"	2-3/8"	1-1/4"

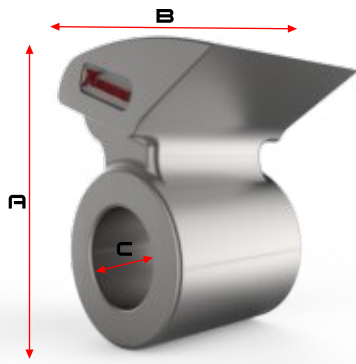

aftermarket replacement for:  
**SEPPI**  
fit models - MIDIFORST

### XFM-FA132

SWINGING HAMMER

CUTTER TYPE	STEEL TYPE	STEEL HARDNESS	SHAFT REQUIRED	WEIGHT	A	B	C
Wood	40CrMo	HRC40-42	1-1/4" Dia	4.00 lbs	3-5/8"	3"	1-1/4"

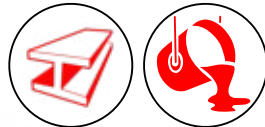
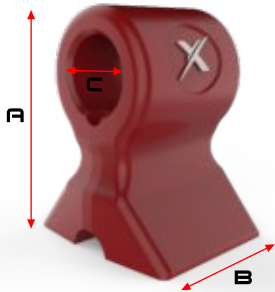

aftermarket replacement for:  
**SEPPI**  
fit models - MINI BMS, BMS, H-SMWA-K, BMS-L, MINIFORST, MIDIFORST dt

### XFM-SE210

SWINGING HAMMER - REPLACES PART# MIDIFORST-240

CUTTER TYPE	STEEL TYPE	STEEL HARDNESS	SHAFT REQUIRED	WEIGHT	A	B	C
Wood	40CrMo	HRC40-42	1-1/4" Dia	4.00 lbs	3-7/8"	2-9/16"	1-1/4"

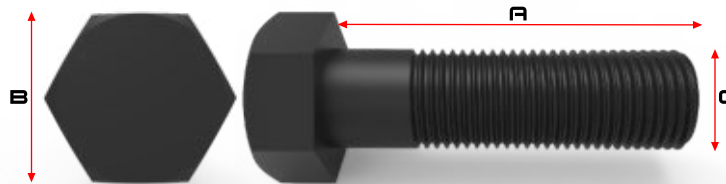

## HEX BOLTS

PART NUMBER	THREAD SIZE	MATERIAL TYPE	GRADE	HEAD TYPE	DRIVE SIZE	A	B	C	FIT TEETH
M16-1.5X90 HEX	M16	Black Oxide Alloy Steel	10.9	Hex	24mm	90mm	24mm	16mm	XFM-SE146 / XFM-SE147

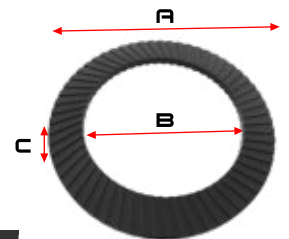

## BEVELLED WASHER

PART NUMBER	MATERIAL TYPE	MATERIAL HARDNESS	SERRATED	A	B	C	FIT TEETH
M16W	Black Oxide Alloy Steel	C40	TOP & BOTTOM	OD	ID	THICKNESS	XFM-SE146 / XFM-SE147