

Square Set Pocket Head

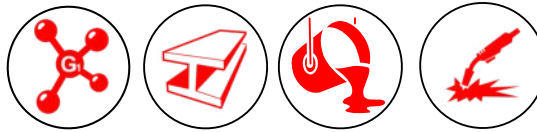
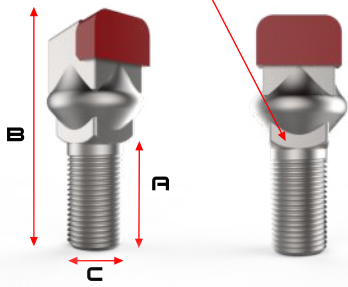

**XSC-NR267-TT**

SHORT SHORT / SQUARE SET POCKET HEAD

CUTTER TYPE	STEEL TYPE	STEEL HARDNESS	THREAD TYPE	WEIGHT	A LENGTH	B LENGTH	C SHAFT DIA
Wood	42CrMo	HRC40-42	5/8-18	0.34 lbs	1-1/8"	2-1/2"	5/8"

aftermarket replacement for:

**SHORT SHORT**  
fits SQUARE SET POCKET HEAD

Square Set Pocket Head

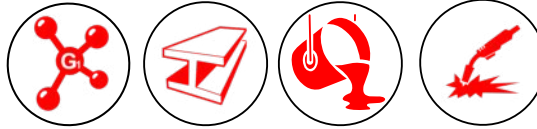
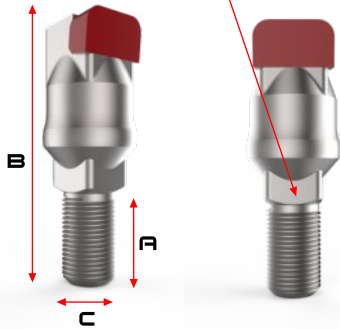

**XSC-NR268-TT**

LONG SHORT / SQUARE SET POCKET HEAD

CUTTER TYPE	STEEL TYPE	STEEL HARDNESS	THREAD TYPE	WEIGHT	A LENGTH	B LENGTH	C SHAFT DIA
Wood	42CrMo	HRC40-42	5/8-18	0.44 lbs	1"	3"	5/8"

aftermarket replacement for:

**LONG SHORT**  
fits SQUARE SET POCKET HEAD

Square Set Pocket Head

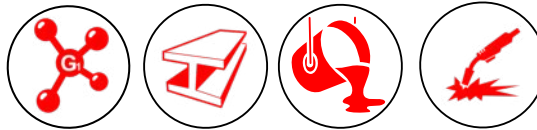
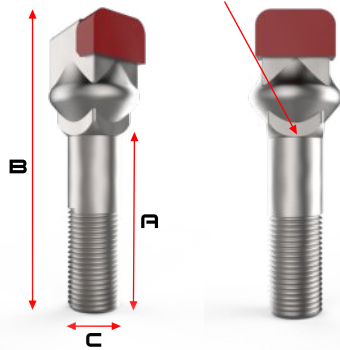

**XSC-AF101-TT**

LONG SIDE / SQUARE SET POCKET HEAD

CUTTER TYPE	STEEL TYPE	STEEL HARDNESS	THREAD TYPE	WEIGHT	A LENGTH	B LENGTH	C SHAFT DIA
Wood	42CrMo	HRC40-42	5/8-18	0.42 lbs	2-1/8"	3-1/2"	5/8"

aftermarket replacement for:

**LONG SIDE**  
fits SQUARE SET POCKET HEAD

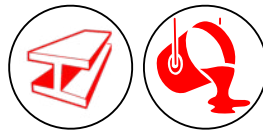
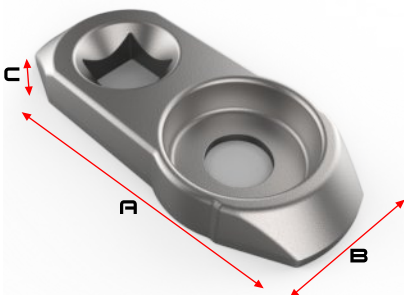

**XFM-XW314-H**

SQUARE POCKET HEAD

STEEL TYPE	STEEL HARDNESS	HOLE DIAMETER	WEIGHT	A LENGTH	B LENGTH	C LENGTH
42CrMo	HRC40-42	5/8"	0.45 lbs	3-13/16"	1-5/8"	1/4"

aftermarket replacement for:

**PLOW BOLTHOLDER**  
fits SQUARE SET POCKET HEAD

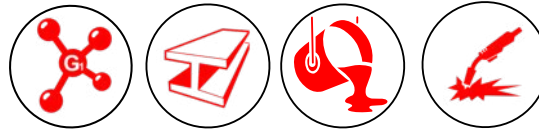
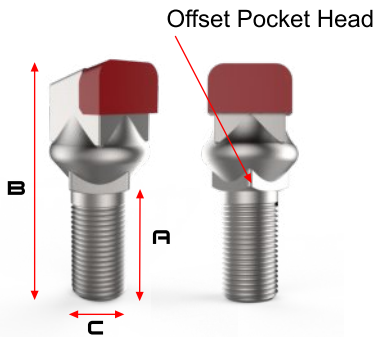

**XSC-CA190-TT**  
SHORT / OFFSET POCKET HEAD

CUTTER TYPE	STEEL TYPE	STEEL HARDNESS	THREAD TYPE	WEIGHT	A LENGTH	B LENGTH	C SHAFT DIA
Wood	42CrMo	HRC40-42	5/8-18	0.34 lbs	1-1/8"	2-1/2"	5/8"

aftermarket replacement for:  
**SHORT SHORT**  
fits OFFSET POCKET HEAD

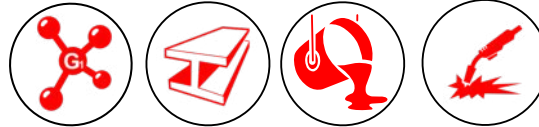
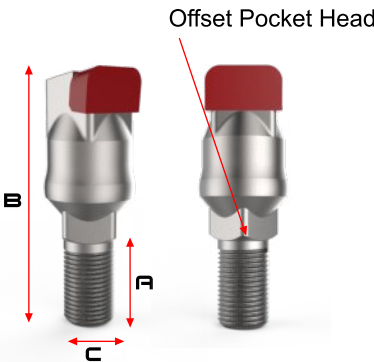

**XSC-CA191-TT**  
SHORT EXTENDED / OFFSET POCKET HEAD

CUTTER TYPE	STEEL TYPE	STEEL HARDNESS	THREAD TYPE	WEIGHT	A LENGTH	B LENGTH	C SHAFT DIA
Wood	42CrMo	HRC40-42	5/8-18	0.44 lbs	1"	3"	5/8"

aftermarket replacement for:  
**LONG SHORT**  
fits OFFSET POCKET HEAD

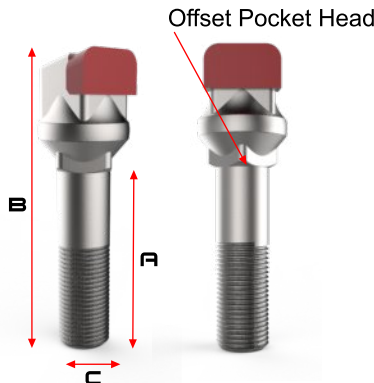

**XSC-CA192-TT**  
LONG / OFFSET POCKET HEAD

CUTTER TYPE	STEEL TYPE	STEEL HARDNESS	THREAD TYPE	WEIGHT	A LENGTH	B LENGTH	C SHAFT DIA
Wood	42CrMo	HRC40-42	5/8-18	0.42 lbs	2-1/8"	3-1/2"	5/8"

aftermarket replacement for:  
**LONG SIDE**  
fits OFFSET POCKET HEAD

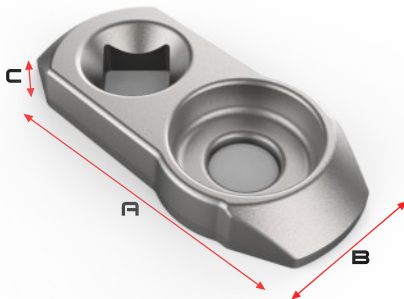

**XFM-XW315-H**  
OFFSET / DIAMOND POCKET HEAD

STEEL TYPE	STEEL HARDNESS	HOLE DIAMETER	WEIGHT	A LENGTH	B LENGTH	C LENGTH
42CrMo	HRC40-42	5/8"	0.45 lbs	3-13/16"	1-5/8"	1/4"

aftermarket replacement for:  
**PLOW BOLTHOLDER**  
fits OFFSET / DIAMOND POCKET HEAD

aftermarket replacement for:  
**SHORT SHORT**  
fits HEX HEAD POCKET POCKET

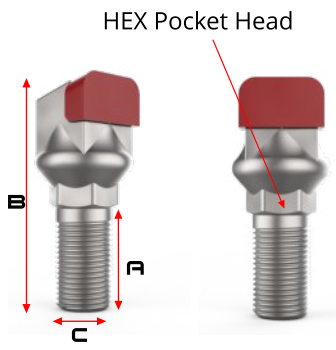

**XSC-HEX316**  
SHORT / SHORT HEX SET POCKET HEAD

CUTTER TYPE	STEEL TYPE	STEEL HARDNESS	THREAD TYPE	WEIGHT	A LENGTH	B LENGTH	C SHAFT DIA
Wood	42CrMo	HRC40-42	5/8-18	0.34 lbs	1-1/2"	2-1/2"	5/8"

aftermarket replacement for:  
**LONG SHORT**  
fits HEX HEAD POCKET POCKET

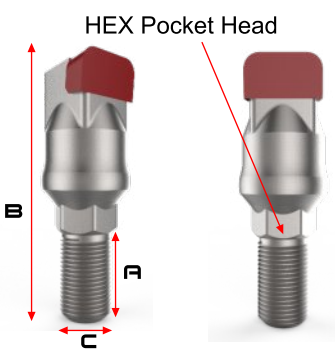

**XSC-HEX284**  
LONG / SHORT HEX SET POCKET HEAD

CUTTER TYPE	STEEL TYPE	STEEL HARDNESS	THREAD TYPE	WEIGHT	A LENGTH	B LENGTH	C SHAFT DIA
Wood	42CrMo	HRC40-42	5/8-18	0.44 lbs	1"	3"	5/8"

aftermarket replacement for:  
**LONG SIDE**  
fits HEX HEAD POCKET HEAD

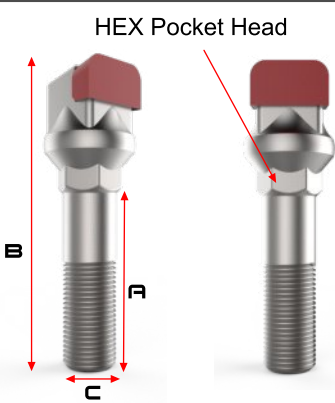

**XSC-HEX283**  
LONG SIDE HEX SET POCKET HEAD

CUTTER TYPE	STEEL TYPE	STEEL HARDNESS	THREAD TYPE	WEIGHT	A LENGTH	B LENGTH	C SHAFT DIA
Wood	42CrMo	HRC40-42	5/8-18	0.42 lbs	2-1/8"	3-1/2"	5/8"

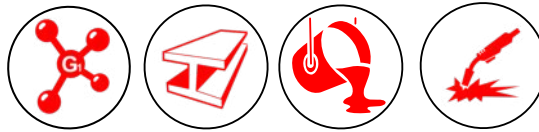
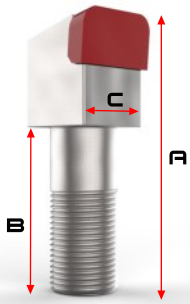

aftermarket replacement for:  
**2-1/2" BIT**  
fits SQUARE SET POCKET HEAD

**XSC-XW312**  
SHORT HEAD

CUTTER TYPE	STEEL TYPE	STEEL HARDNESS	THREAD TYPE	WEIGHT	A LENGTH	B LENGTH	C WIDTH
Wood	42CrMo	HRC40-42	5/8-18	0.35 lbs	2-1/2"	1-1/2"	3/4"

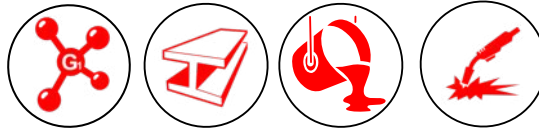
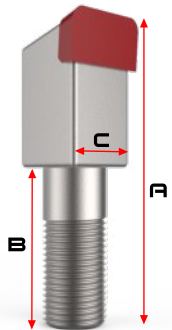

aftermarket replacement for:  
**2-7/8" BIT**  
fits SQUARE SET POCKET HEAD

**XSC-BA282**  
LONG HEAD

CUTTER TYPE	STEEL TYPE	STEEL HARDNESS	THREAD TYPE	WEIGHT	A LENGTH	B LENGTH	C WIDTH
Wood	42CrMo	HRC40-42	5/8-18	0.35 lbs	2-7/8"	1-1/2"	3/4"

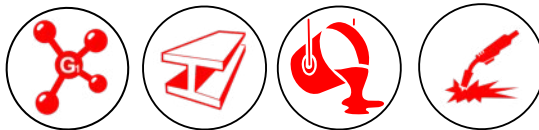
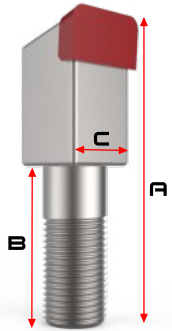

aftermarket replacement for:  
**2-3/4" BIT**  
fits SQUARE SET POCKET HEAD

**XSC-XW313**  
WOODLAND MILLS

CUTTER TYPE	STEEL TYPE	STEEL HARDNESS	THREAD TYPE	WEIGHT	A LENGTH	B LENGTH	C WIDTH
Wood	42CrMo	HRC40-42	M16x1.5	0.35 lbs	2-3/4"	1-1/2"	11/16"

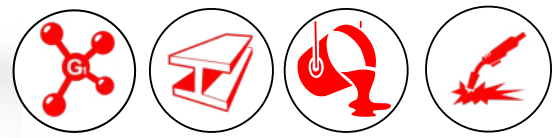
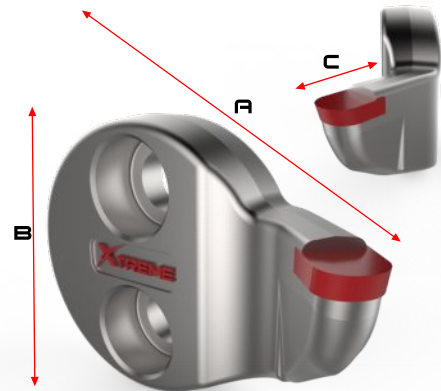

**XSC-RA148**  
ANGLED/BORED

CUTTER TYPE	STEEL TYPE	STEEL HARDNESS	HOLE OPENING	WEIGHT
Wood	42CrMo	HRC40-42	OD 15/16, ID 5/8"	1.53 lbs

aftermarket replacement for:  
**ANGLED**  
replaces dual 5/8" bolt  
stump grinder teeth

A	B	C
LENGTH	WIDTH	LENGTH
4-1/4"	2-13/16"	1-1/2"

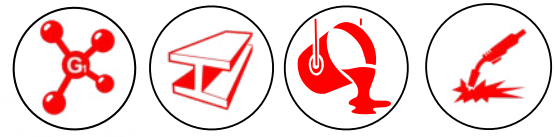

**XSC-RA149**  
ANGLED/THREADED

CUTTER TYPE	STEEL TYPE	STEEL HARDNESS	THREAD TYPE	WEIGHT
Wood	42CrMo	HRC40-42	5/8-18"	1.53 lbs

aftermarket replacement for:  
**ANGLED**  
replaces dual 5/8" bolt  
stump grinder teeth

A	B	C
LENGTH	WIDTH	LENGTH
4-1/4"	2-13/16"	1-1/2"

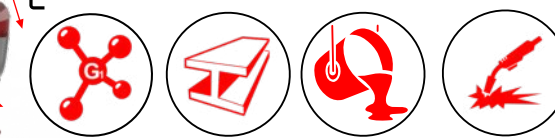
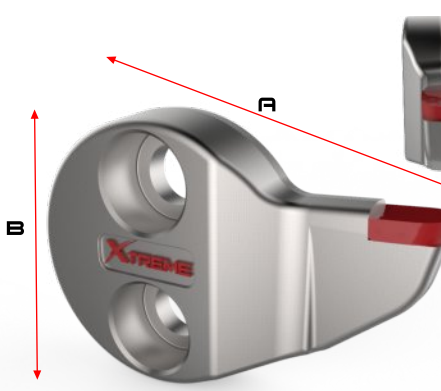

**XSC-RA150**  
STRAIGHT/BORED

CUTTER TYPE	STEEL TYPE	STEEL HARDNESS	HOLE OPENING	WEIGHT
Wood	42CrMo	HRC40-42	OD 15/16, ID 5/8"	1.59 lbs

aftermarket replacement for:  
**STRAIGHT**  
replaces dual 5/8" bolt  
stump grinder teeth

A	B	C
LENGTH	WIDTH	LENGTH
4-1/4"	2-13/16"	1-1/2"

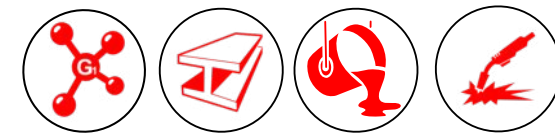

**XSC-RA151**  
STRAIGHT/THREADED

CUTTER TYPE	STEEL TYPE	STEEL HARDNESS	THREAD TYPE	WEIGHT
Wood	42CrMo	HRC40-42	5/8-18"	1.59 lbs

aftermarket replacement for:  
**STRAIGHT**  
replaces dual 5/8" bolt  
stump grinder teeth

A	B	C
LENGTH	WIDTH	LENGTH
4-1/4"	2-13/16"	1-1/2"

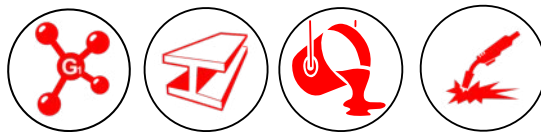
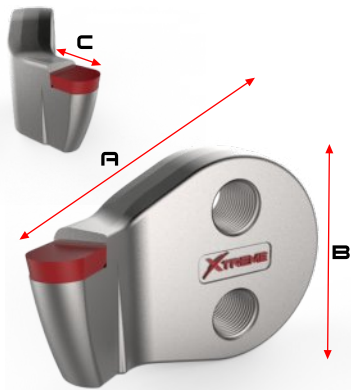

**XSC-RA235**  
ANGLED/THREADED

CUTTER TYPE	STEEL TYPE	STEEL HARDNESS	THREAD SIZE	WEIGHT
Wood	42CrMo	HRC40-42	7/8"-14	3.96 lbs

aftermarket replacement for:  
**ANGLED**  
replaces dual 7/8" bolt  
stump grinder teeth

A	B	C
LENGTH	WIDTH	LENGTH
6"	3-5/8"	1-3/4"

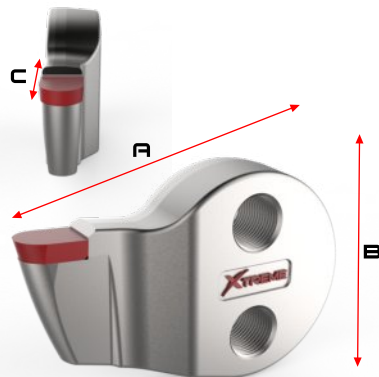

**XSC-RA236**  
STRAIGHT/THREADED

CUTTER TYPE	STEEL TYPE	STEEL HARDNESS	THREAD SIZE	WEIGHT
Wood	42CrMo	HRC40-42	7/8"-14	3.56 lbs

aftermarket replacement for:  
**STRAIGHT**  
replaces dual 7/8" bolt  
stump grinder teeth

A	B	C
LENGTH	WIDTH	LENGTH
5-1/4"	3-5/8"	1-3/4"

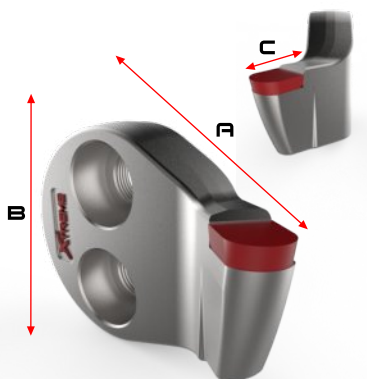

**XSC-RA237**  
ANGLED/COUNTER BORED

CUTTER TYPE	STEEL TYPE	STEEL HARDNESS	THREAD SIZE	WEIGHT
Wood	42CrMo	HRC40-42	7/8"-14	3.60 lbs

aftermarket replacement for:  
**ANGLED**  
replaces dual 7/8" bolt  
stump grinder teeth

A	B	C
LENGTH	WIDTH	LENGTH
6"	3-5/8"	1-3/4"

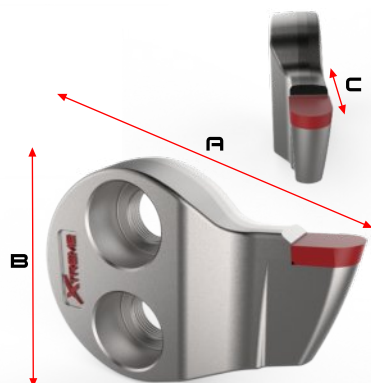

**XSC-RA238**  
STRAIGHT/COUNTER BORED

CUTTER TYPE	STEEL TYPE	STEEL HARDNESS	THREAD SIZE	WEIGHT
Wood	42CrMo	HRC40-42	7/8"-14	3.28 lbs

aftermarket replacement for:  
**STRAIGHT**  
replaces dual 7/8" bolt  
stump grinder teeth

A	B	C
LENGTH	WIDTH	LENGTH
5-1/4"	3-5/8"	1-3/4"

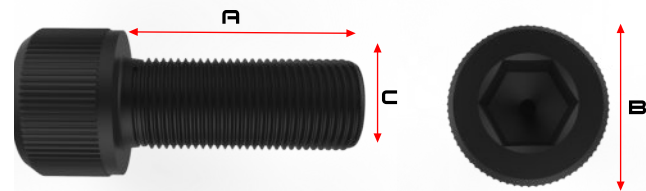

## SOCKET BOLTS

PART NUMBER	THREAD SIZE	MATERIAL TYPE	GRADE	HEAD TYPE	DRIVE SIZE	A	B	C	FIT DISC WIDTH
						LENGTH	DIA	DIA	
5/8-18x1-1/2" SKT	5/8-18"	Black Oxide Alloy Steel	8	Socket	1/2"	1-1/2"	15/16"	5/8"	3/8"
5/8-18x1-3/4" SKT	5/8-18"	Black Oxide Alloy Steel	8	Socket	1/2"	1-3/4"	15/16"	5/8"	1/2"
5/8-18x2" SKT	5/8-18"	Black Oxide Alloy Steel	8	Socket	1/2"	2"	15/16"	5/8"	3/4"
5/8-18x2-1/4" SKT	5/8-18"	Black Oxide Alloy Steel	8	Socket	1/2"	2-1/4"	15/16"	5/8"	1"
5/8-18x2-3/4" SKT	5/8-18"	Black Oxide Alloy Steel	8	Socket	1/2"	2-3/4"	15/16"	5/8"	1-1/2"
7/8-14x3" SKT	7/8-14"	Black Oxide Alloy Steel	8	Socket	3/4"	3"	1-5/16"	7/8"	1-1/2"
7/8-14x4-1/2" SKT	7/8-14"	Black Oxide Alloy Steel	8	Socket	3/4"	4-1/2"	1-5/16"	7/8"	3"

## IMPACT RACHET ADAPTER

PART NUMBER	MALE SOCKET SIZE	DRIVE SIZE	FITS BOLT SIZE
IMPACT-1/2	1/2"	3/4"	5/8-18" SKT

